

Fully In-House Production Process

100% Made in Italy

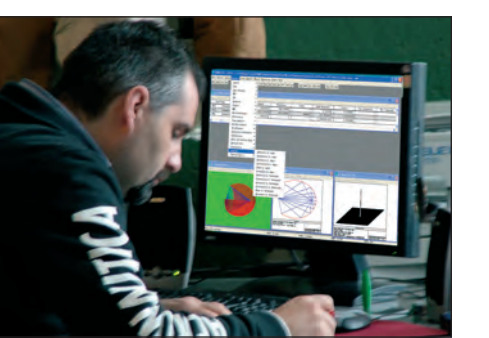

Optical Study and Design



Tooling Design and Development



Tooling Manufacturing

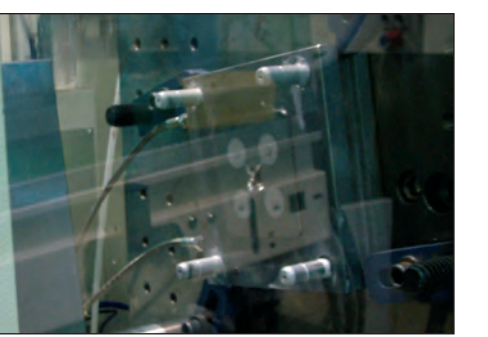

In-House Production



High Production Capacity



Fully automatic robotized machines



Automated Production and Control System



100% Testing carried out in the Dark Room

www.khatod.com

KHATOD[®]
OPTOELECTRONIC

HEAD QUARTER
20092 Cinisello Balsamo (Milan) Italy • Via Monfalcone 41
Phone +39 02 66013695 • Fax +39 02 66013500
E-mail khatod@khatod.com
www.khatod.com

KHATOD Sales Offices & Distributors

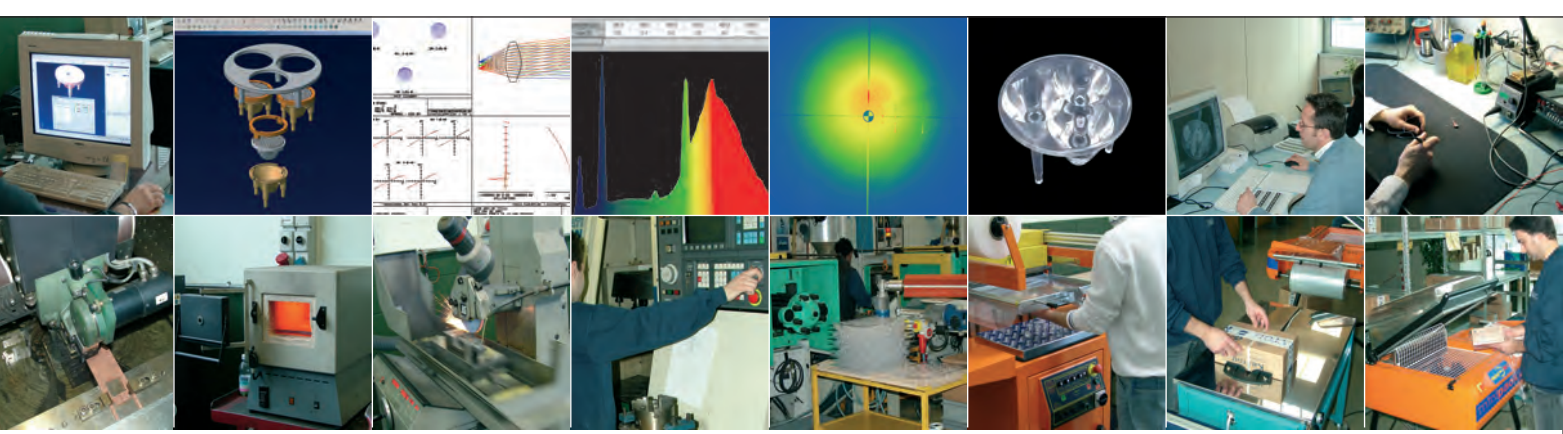
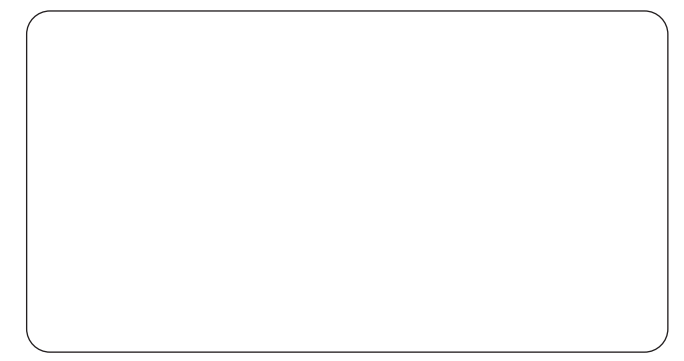

www.khatod.com - printed in april 2009 - Cat.004



our commitment to the environment

KHATOD

Lenses & Optical Systems for Power LEDs

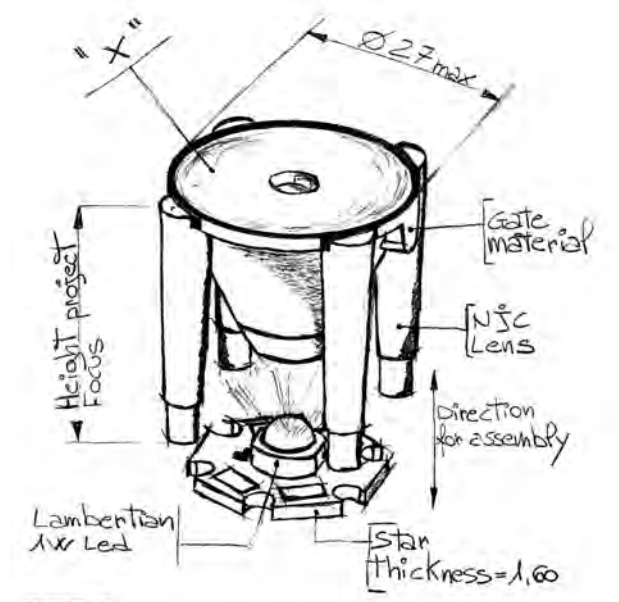

NOTE:
X = Different surface for different light beam angle.

Since 1985
Exclusively Made in Italy

www.khatod.com

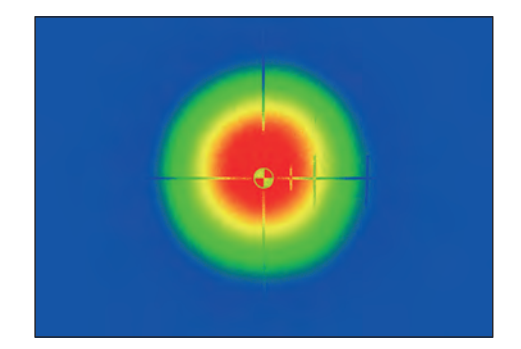

Narrow Beam

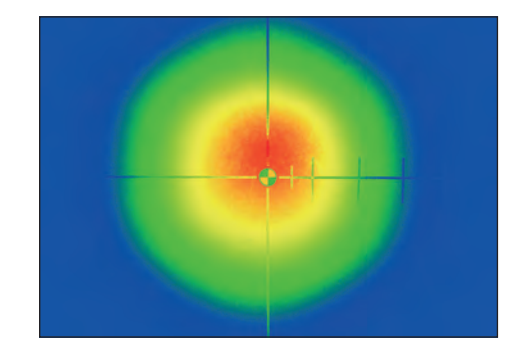

Medium Beam

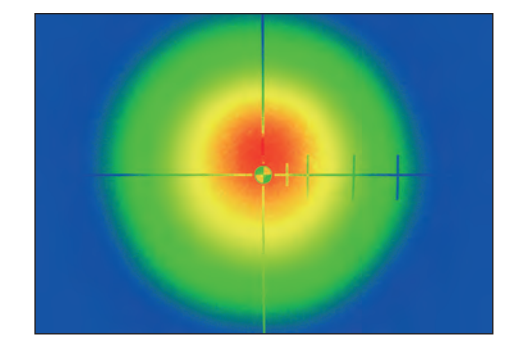

Medium Beam Frozen Effect

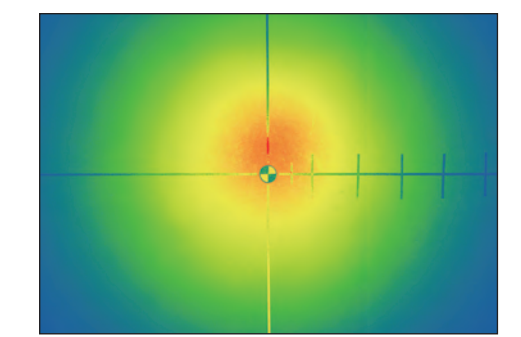

Wide Beam

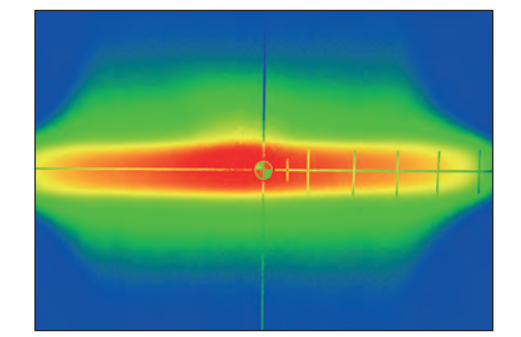

Blade Beam

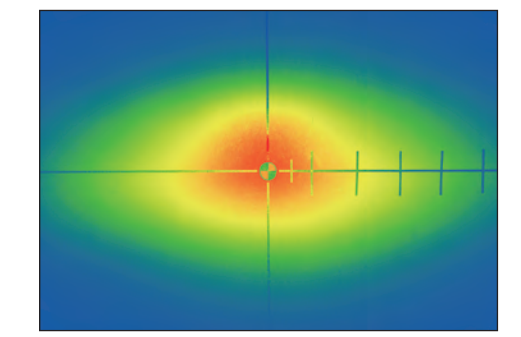

Elliptical Beam

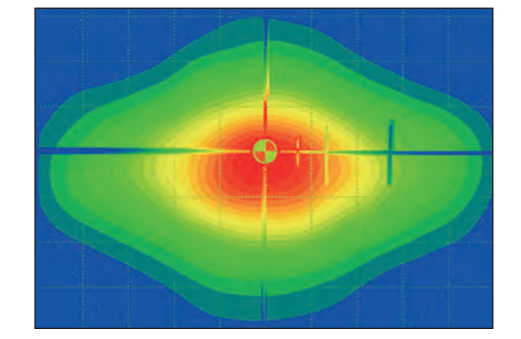

Asymmetrical Beam

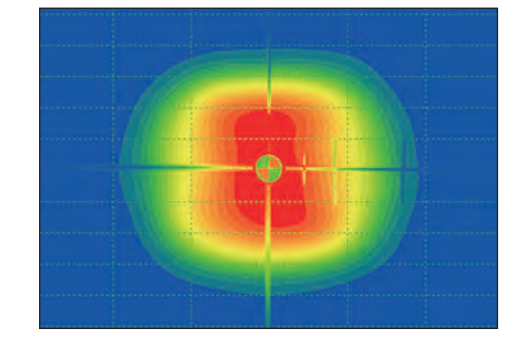

Fresnel Technology

For further details, technical specifications and any information relative to products and brands not represented in the catalogue, please visit our website www.khatod.com

Fabbrica Italiana Optoelettronica & Lenti Sintetiche

